

NEW! ACCORD 15 EXPRESS SYSTEM

*The
Complete
Signage
Solution!*

Your Source for Sign Components



Accord¹⁵

A Modular Sign System

Accord¹⁵ is a complete, modular system ideal for virtually any signage need, from simple personnel and identification signs, to complex directionals and directories. Offering easy, cost-effective signage solutions while retaining unparalleled design flexibility, modularity, and quality is what Accord¹⁵ is all about.

System Overview

Accord¹⁵ is comprised of two systems which share a wide range of modular components.

End Clip System Features a wide range of extruded aluminum bands (inserts) which snap onto low profile, integrally colored End Clips. It couldn't be easier! Ideal for personnel signs, directional modules, room identification, and ceiling and wall projection signs.

Side Track System Features the same range of aluminum bands which snap onto aluminum Side Tracks via modular Clip fasteners, ensuring modularity and precise alignment of inserts. Ideal for room signs, directories, directional signs, poster holders, and more, for both interior and exterior applications.

Features/Benefits

- **It's Easy!**
Ordering, installation and servicing couldn't be easier!
- **User Lettering Capabilities**
A wide range of Accord inserts allow for economical, easily updateable paper or vinyl inserts.
- **Low Profile**
The Accord End Clip system features a sleek 3/8"/9.5mm depth.
- **Design Flexibility**
Accord's wide range of inserts, shapes, and decorative elements allows for unique, great looking systems based around standard components.
- **Colors & Finishes**
(6) Standard - consult APCO for details.

End Clip System

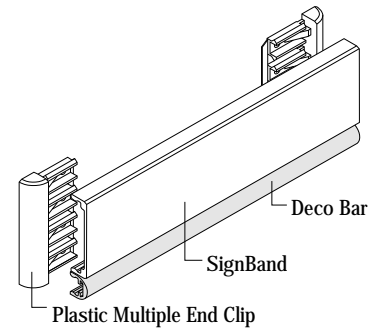
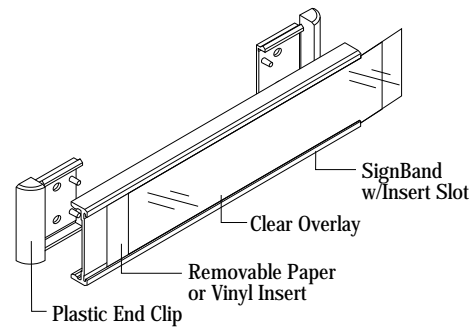

The Basic Components

1 End Clips

Single Insert Clips

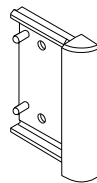

Radius

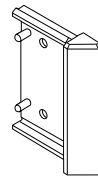

Bevel

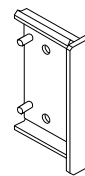

Square

Multiple Insert Clips

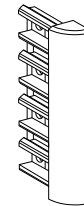

Radius

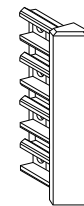

Bevel

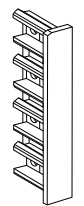

Square

2 Inserts* (Snap onto End Clips)

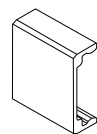

SignBands

- (8) Sizes
- Curved Face Option
- Custom Sizes Possible

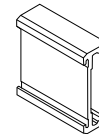

SignBands w/Insert Slot

- (5) Standard Sizes
- Compatible with APCO SignWord paper inserts.



Decorative Elements

- (3) Options/ Shapes

Applications

The Essentials:

- Personnel Signs
- Information Signs
- Identification/Room Signs
- Directories/Directional Signs

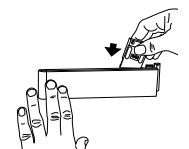
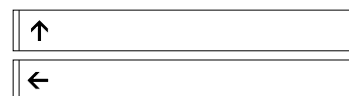
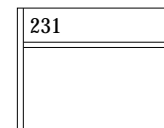
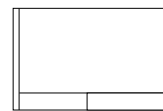
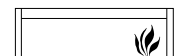

Side Track System

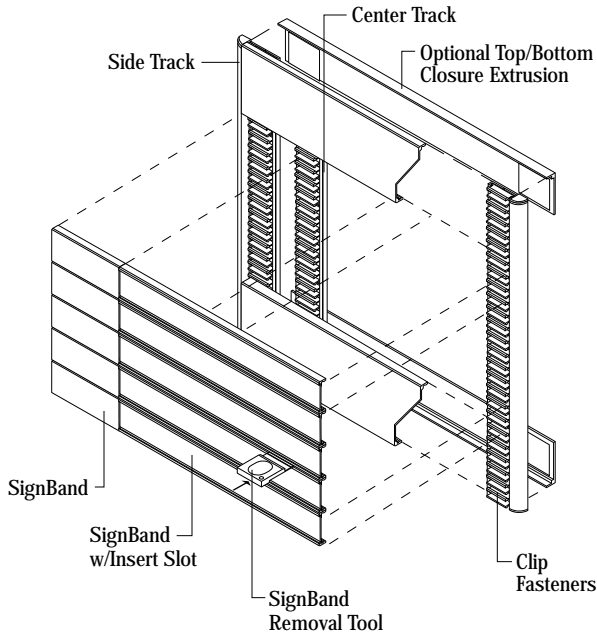

The Basic Components

1 Aluminum Side Tracks

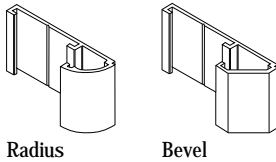

Radius

Bevel

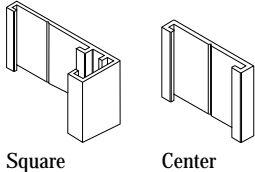

Square

Center

2 Clip Fasteners (Lock into Side Track)

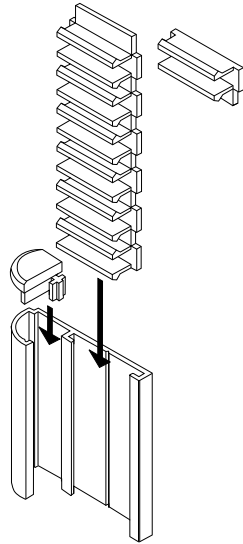

3 Inserts* (Snap onto Clips)

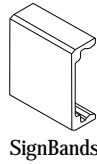

SignBands

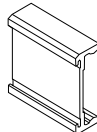

SignBands w/Insert Slot



Decorative Elements

Applications

The Essentials:

- Information Signs
- Identification/Room Signs
- Directories/Directional Signs
- Window Signs

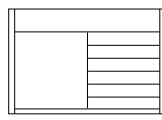
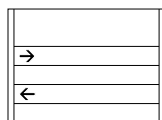
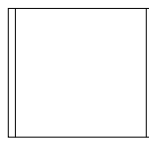
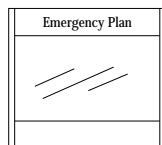
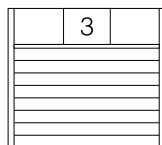

Accord¹⁵ Express

The Simple Economical Sign System

Directly from stock, in integrally colored injection molded plastic, offering standard sizes and colors, in both ColorBands and ClearBands. Accord Express is the most economical and expedient way to enjoy the modular benefits of the award-winning, comprehensive Accord15 system.



NEW!



▲ Color Band

Color Bands are precisely molded in (5) standard, integral colors, and are compatible with all Accord15 plastic EndClips and aluminum SideTracks.

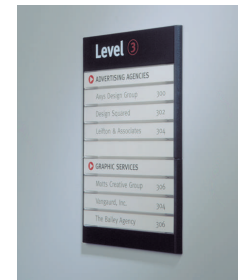

NEW!



▲ Clear Band*

The unique, patent-pending Clear Band is injection molded in a crystal clear plastic for subsurface, laser printed inserts. Graphics are protected by the non-glare, clear plastic and are quickly and easily updated.



▲ 5 Standard Colors:

(L-R) 02 Black, 44 Brown, 43 Beige, 78 Pearl Grey, 72 Bone White

* Worldwide Patents Applied For

See back page of this brochure or consult APCO for the full range of Accord¹⁵ insert options, sizes and finishes.

SignBands

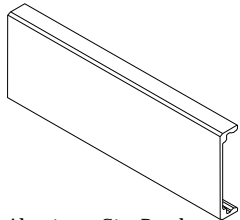

Aluminum SignBands

Code	Size height	Code	Size height
SB15	15mm (9/16")	SBC90	90mm (3-1/2")
SB30	30mm (1-1/8")	SB90	90mm (3-1/2")
SB45	45mm (1-3/4")	SB120	120mm (4-3/4")
SB60	60mm (2-3/8")	SB150A	150mm (5-7/8")
SB75A	75mm (3")		

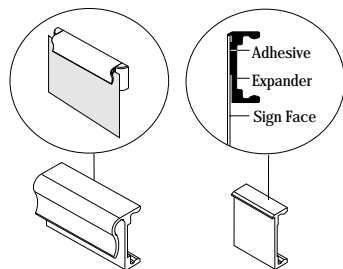

SB30N
30mm/1-1/8"
Notifier

SBE30
30mm/1-1/8"
SignBand
Expander

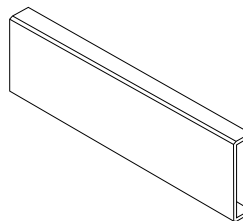

Plastic Color Bands

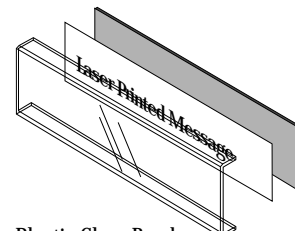

Plastic Clear Bands

Code	Size height x width	Code	Size height x width
SBP30-225	30 x 225mm (1-1/8" x 8-7/8")	SBP30-225-CL	30 x 225mm (1-1/8" x 8-7/8")
SBP45-225	45 x 225mm (1-3/4" x 8-7/8")	SBP45-225-CL	45 x 225mm (1-3/4" x 8-7/8")
SBP60-150	60 x 150mm (2-3/8" x 5-7/8")	SBP60-150-CL	60 x 150mm (2-3/8" x 5-7/8")
SBP60-225	60 x 225mm (2-3/8" x 8-7/8")	SBP60-225-CL	60 x 225mm (2-3/8" x 8-7/8")
SBP150-150	150 x 150mm (5-7/8" x 5-7/8")	SBP150-150-CL	150 x 150mm (5-7/8" x 5-7/8")
SBP150-225	150 x 225mm (5-7/8" x 8-7/8")	SBP150-225-CL	150 x 225mm (5-7/8" x 8-7/8")

End Clips Plastic

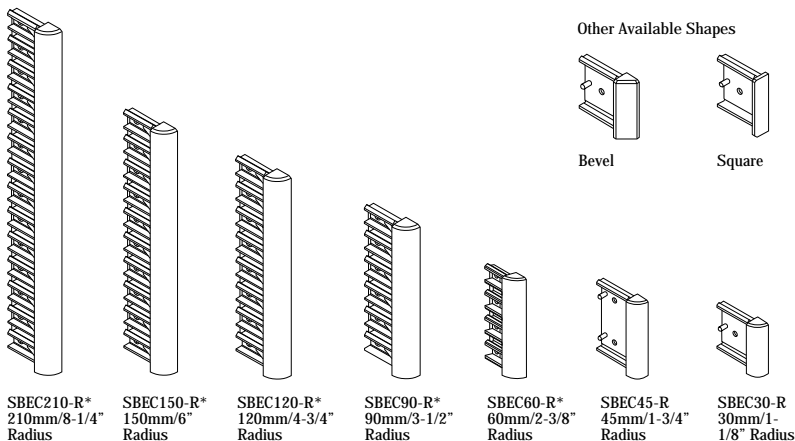

Other Available Shapes

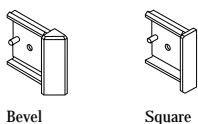

Bevel

Square

SBEC210-R*
210mm/8-1/4"
Radius

SBEC150-R*
150mm/6"
Radius

SBEC120-R*
120mm/4-3/4"
Radius

SBEC90-R*
90mm/3-1/2"
Radius

SBEC60-R*
60mm/2-3/8"
Radius

SBEC45-R
45mm/1-3/4"
Radius

SBEC30-R
30mm/1-1/8"
Radius

SignBands w/Insert Slot

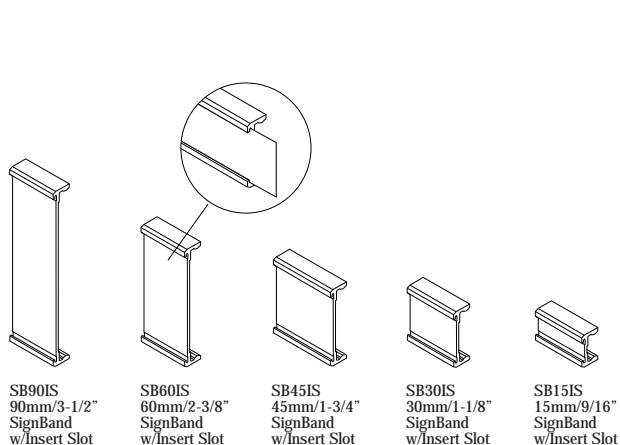

SB90IS
90mm/3-1/2"
SignBand
w/Insert Slot

SB60IS
60mm/2-3/8"
SignBand
w/Insert Slot

SB45IS
45mm/1-3/4"
SignBand
w/Insert Slot

SB30IS
30mm/1-1/8"
SignBand
w/Insert Slot

SB15IS
15mm/9/16"
SignBand
w/Insert Slot

Side Track Components

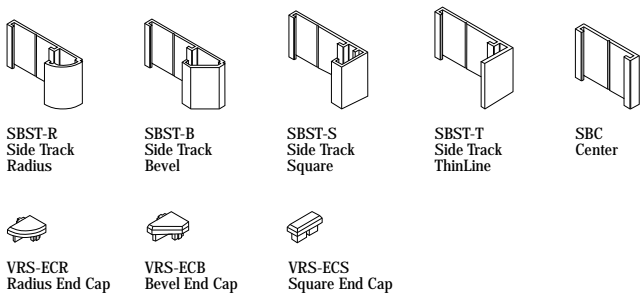

SBST-R
Side Track
Radius

SBST-B
Side Track
Bevel

SBST-S
Side Track
Square

SBST-T
Side Track
ThinLine

SBC
Center

VRS-ECR
Radius End Cap

VRS-ECB
Bevel End Cap

VRS-ECS
Square End Cap

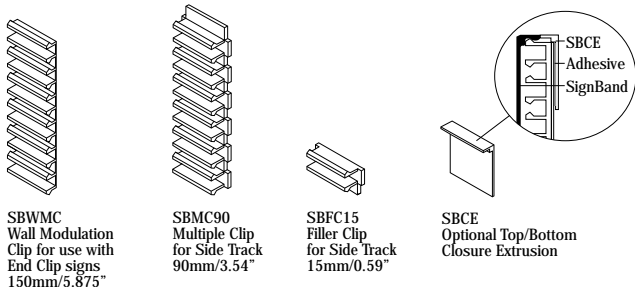

SBWMC
Wall Modulation
Clip for use with
End Clip signs
150mm/5.875"

SBMC90
Multiple Clip
for Side Track
90mm/3.54"

SBFC15
Filler Clip
for Side Track
15mm/0.59"

SBCE
Optional Top/Bottom
Closure Extrusion

Decorative Elements/Slider

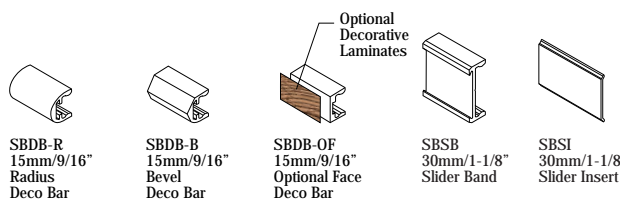

SBDB-R
15mm/9/16"
Radius
Deco Bar

SBDB-B
15mm/9/16"
Bevel
Deco Bar

SBDB-OF
15mm/9/16"
Optional Face
Deco Bar

SBSB
30mm/1-1/8"
Slider Band

SBSI
30mm/1-1/8"
Slider Insert

Miscellaneous Accessories

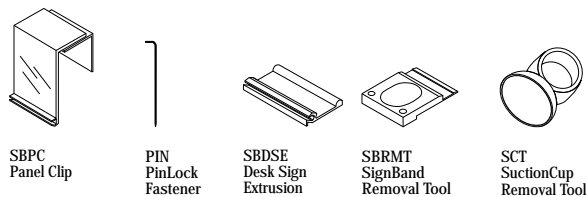

SBPC
Panel Clip

PIN
PinLock
Fastener

SBDS
Desk Sign
Extrusion

SBRMT
SignBand
Removal Tool

SCT
SuctionCup
Removal Tool

Standard Colors/Finishes

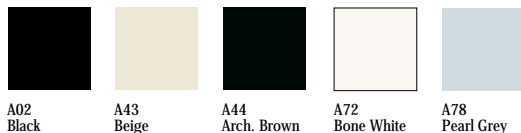

A02
Black

A43
Beige

A44
Arch. Brown

A72
Bone White

A78
Pearl Grey

Metallic Finishes
• Natural Satin Anodized
• Mill
• Black Anodized
(SBC Center Track Only)

Note:
Colors/Finishes may vary from market to market.
Please contact APCO or your local APCO
Distributor for availability of colors.

APCO

APCO USA
Components Division
388 Grant St., SE
Atlanta, GA USA 30312-2227
Web: www.apcocomponents.com
Email: sales@apcocomponents.com
Tel: (800) 215-4039
Fax: (800) FAX-APCO

APCO UK
IKH Estate, Tickhill Road
Balby, Doncaster
England DN4 8QG
Email: apco@norking.com
Tel: 0-1302-311-121
Fax: 0-1302-311-852

* Worldwide
Patents
Applied For